

2

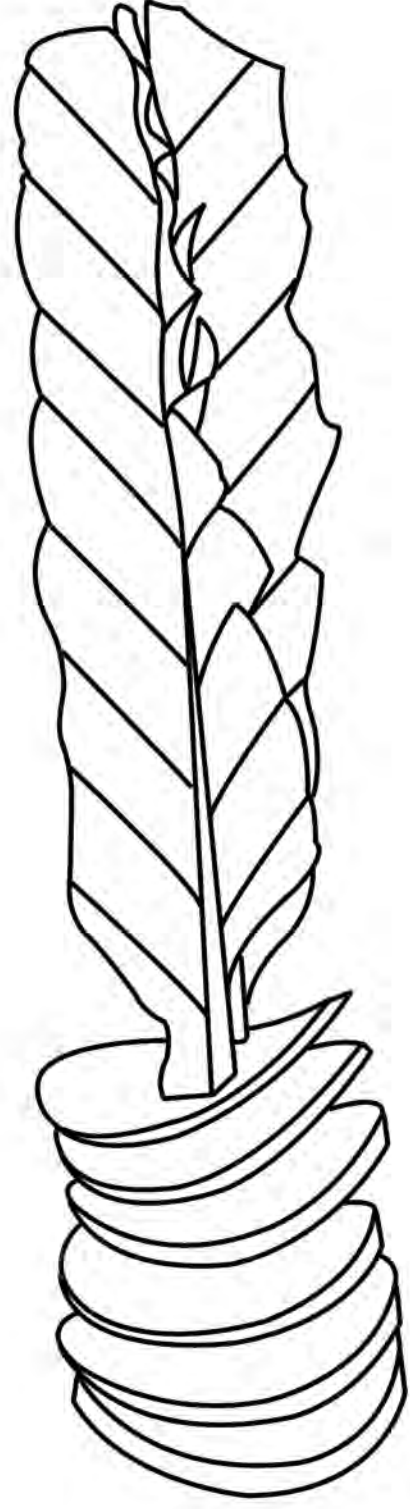

ક

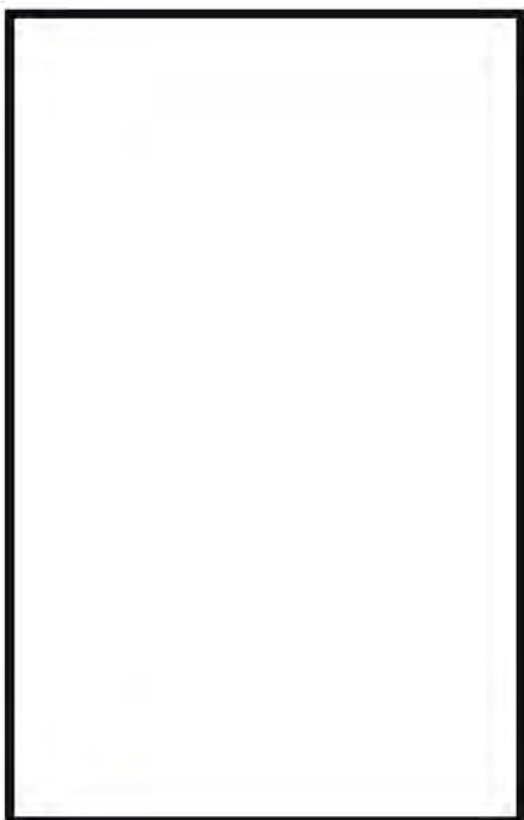

ឈប់

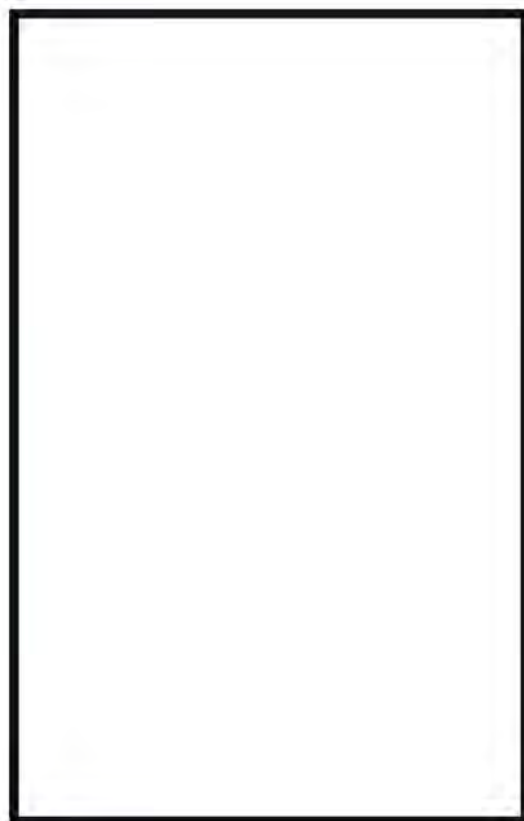

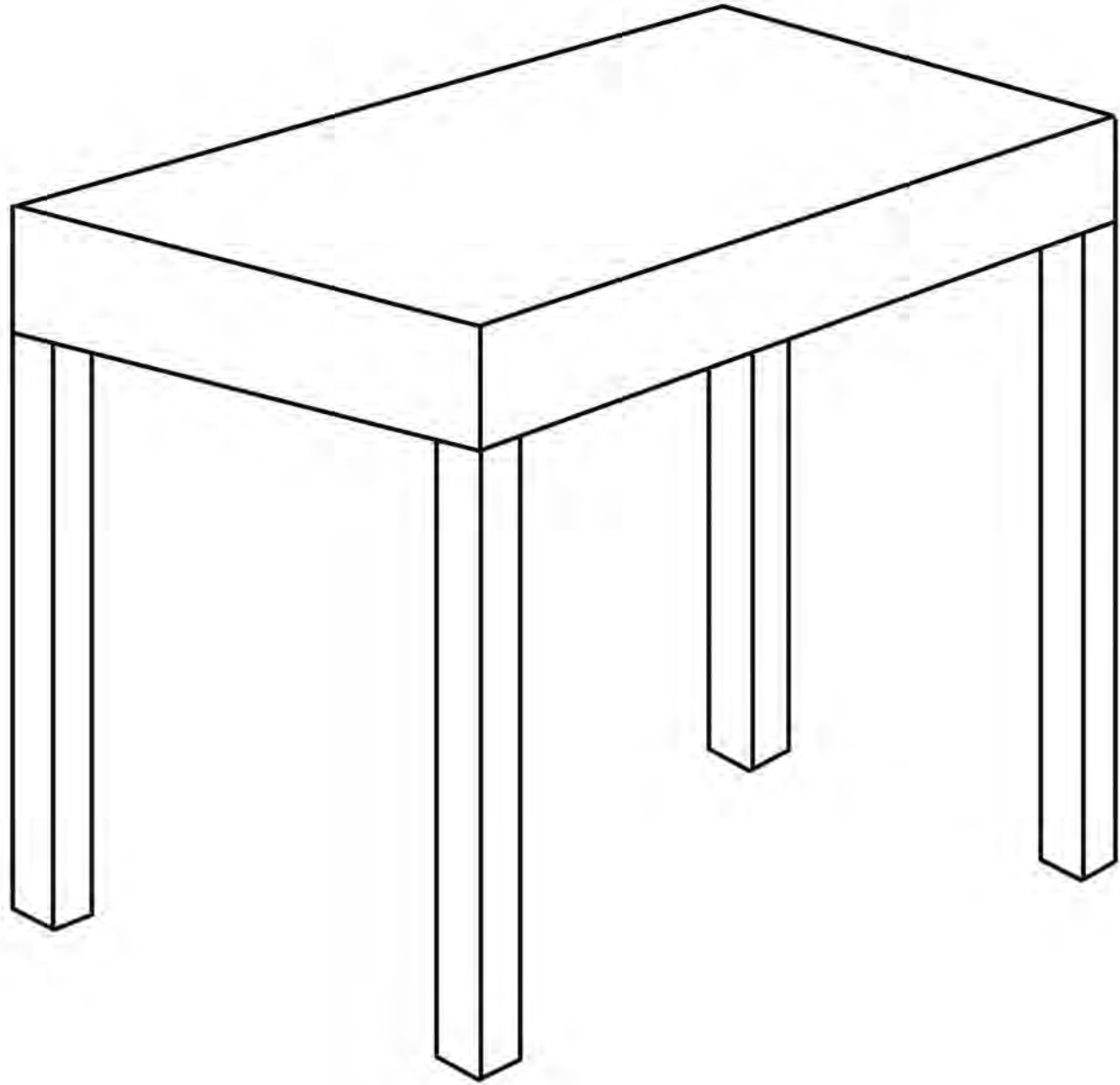
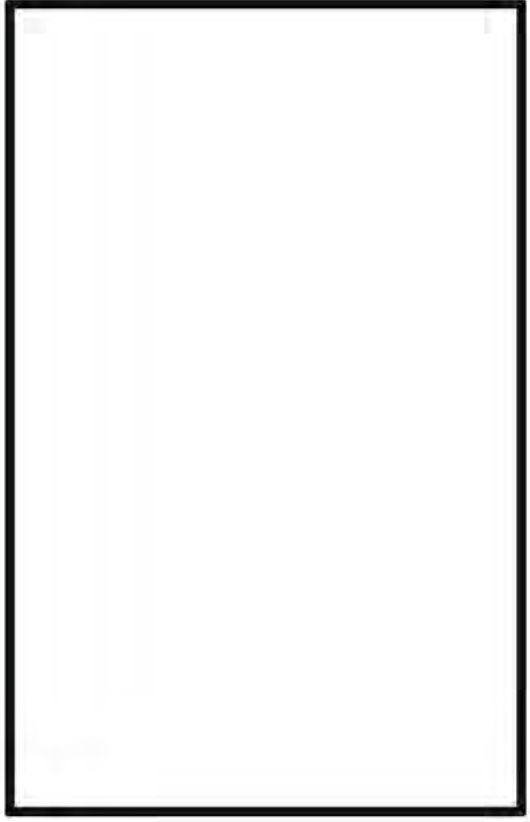

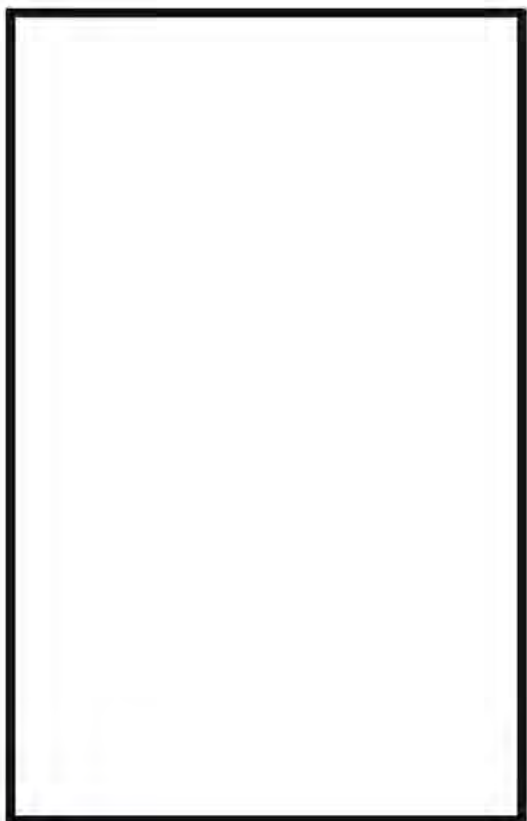
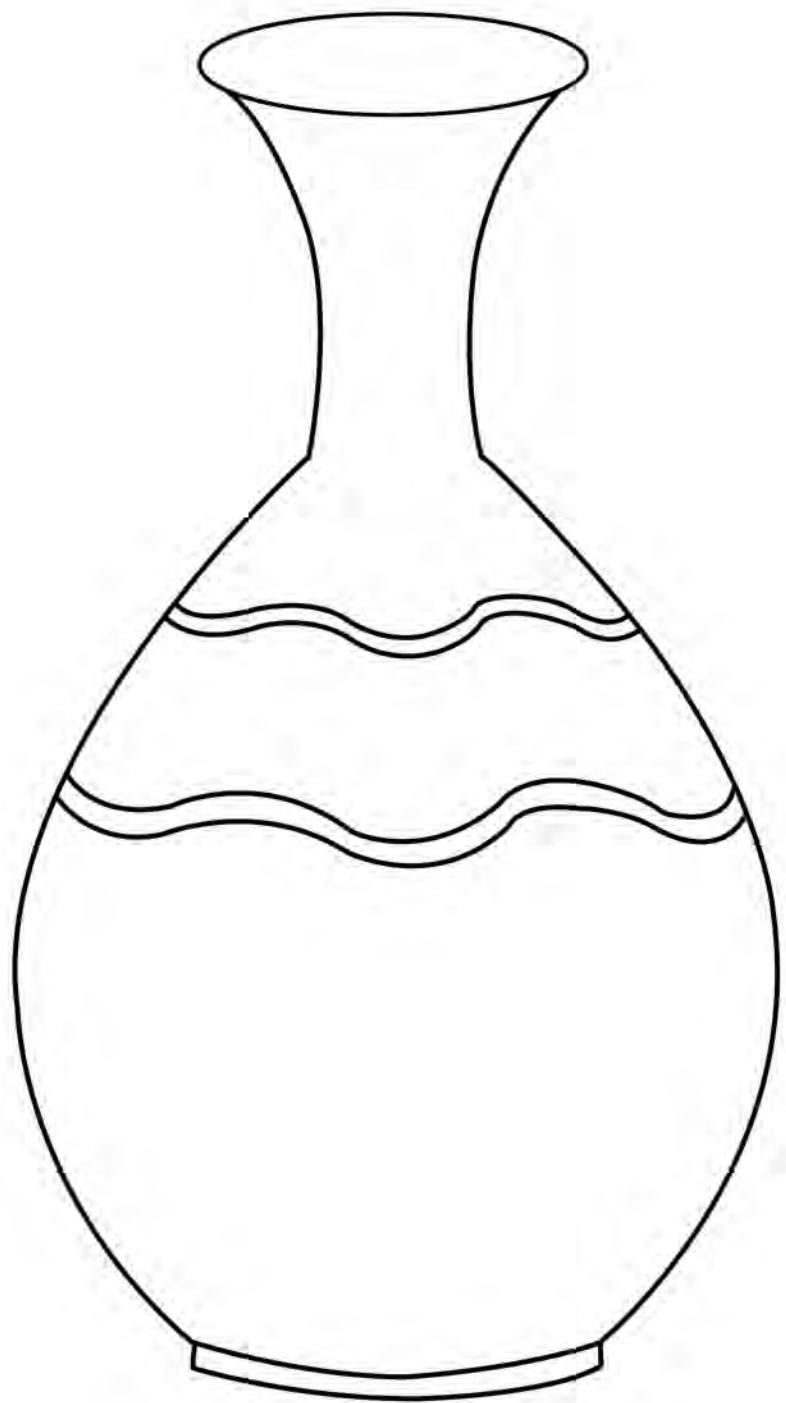

v



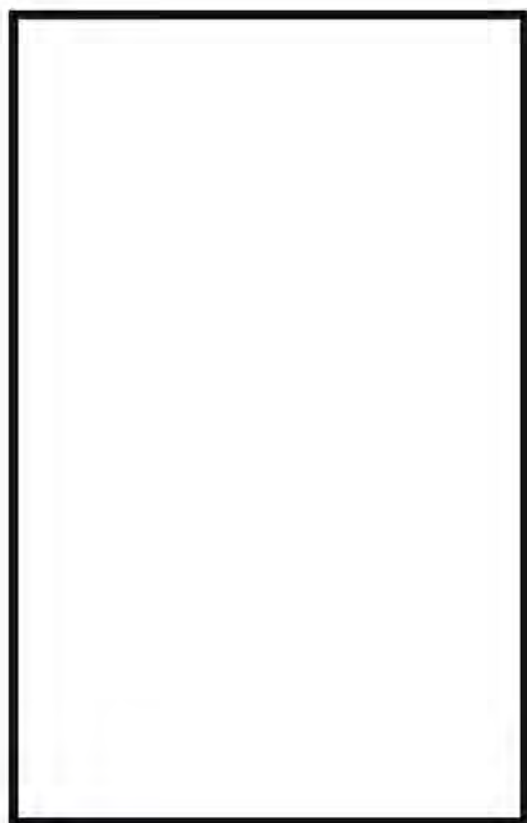

វ

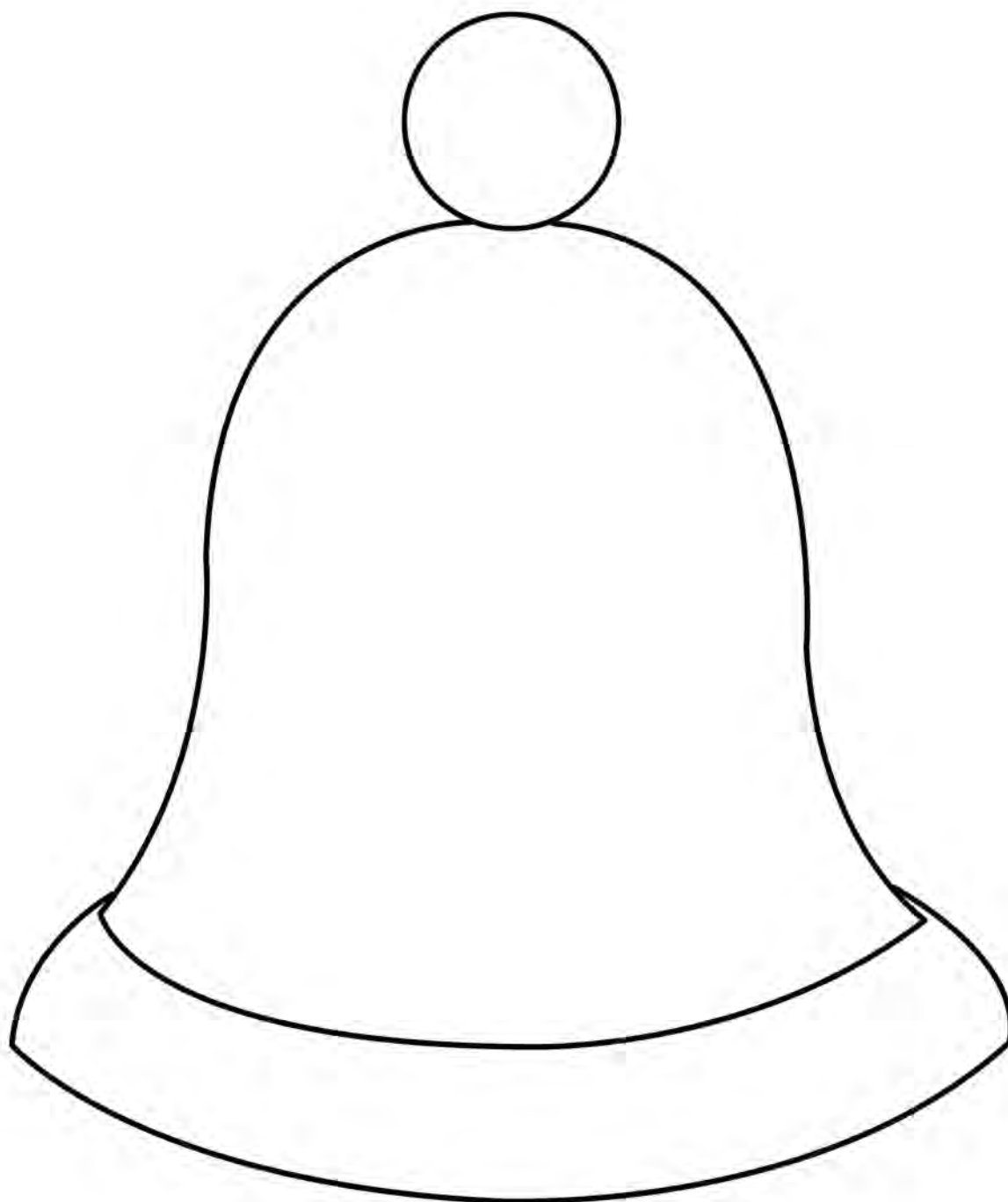

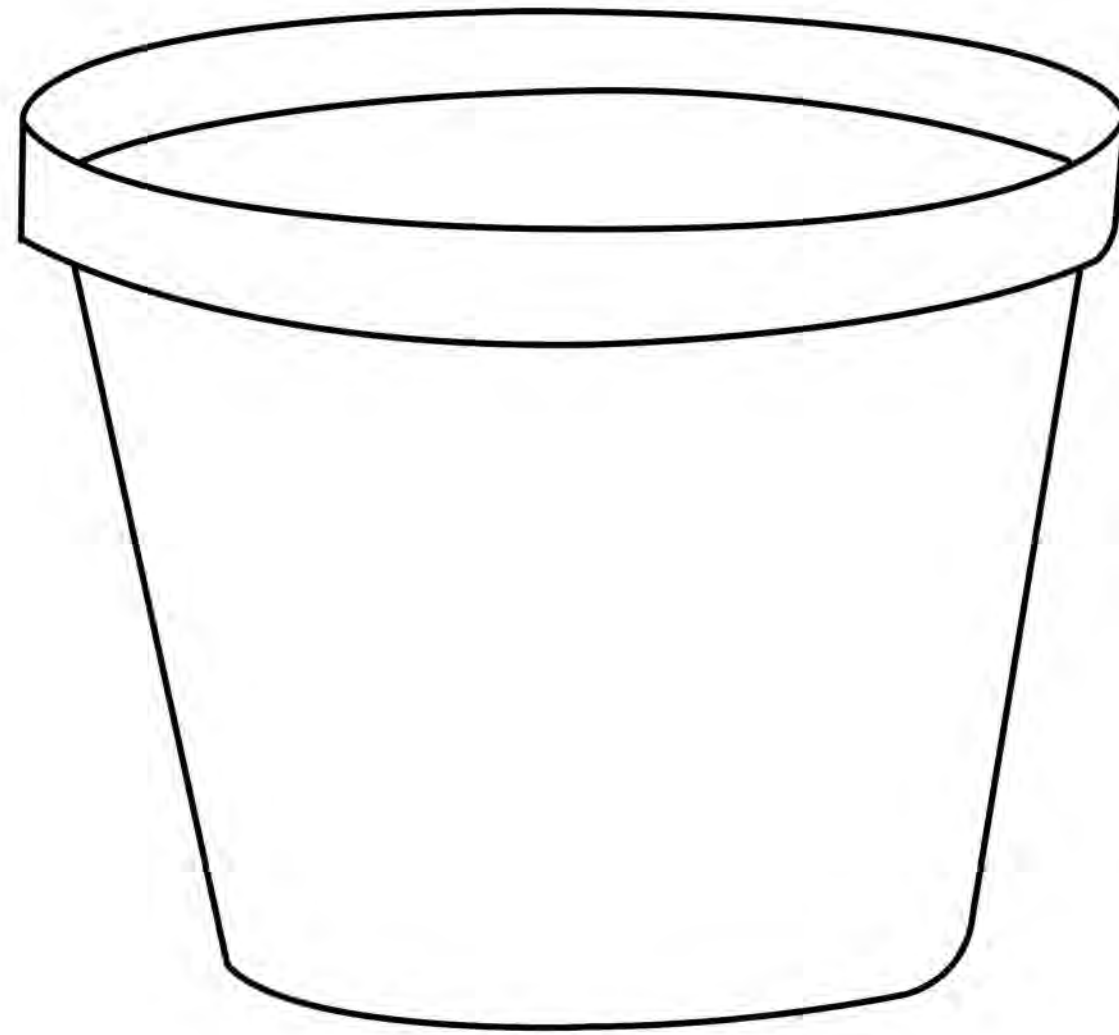

៦

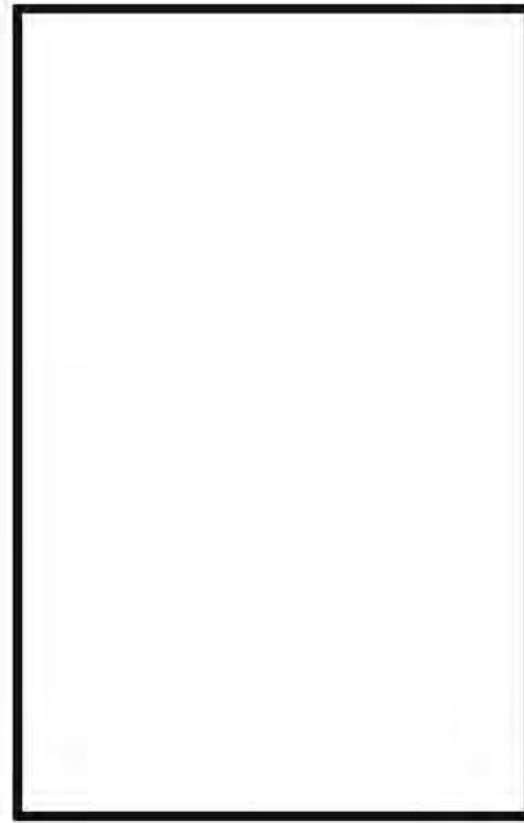

៦

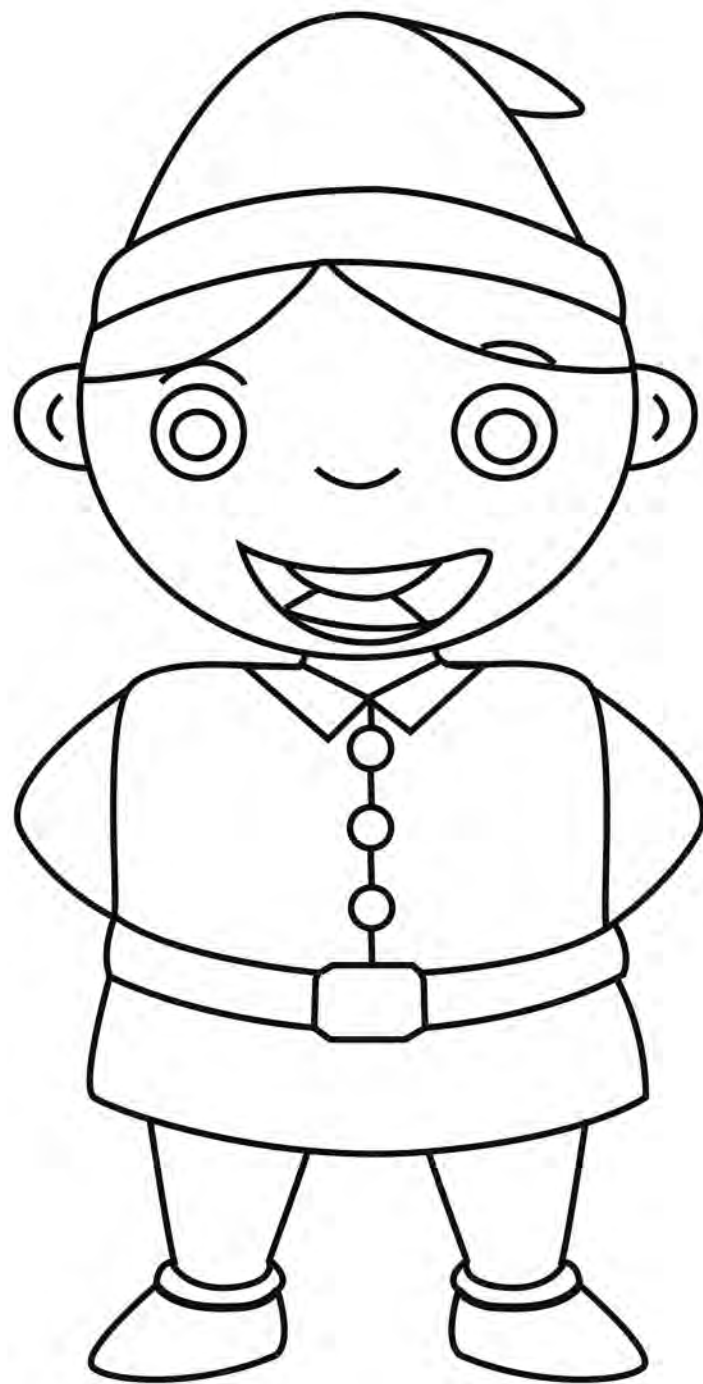
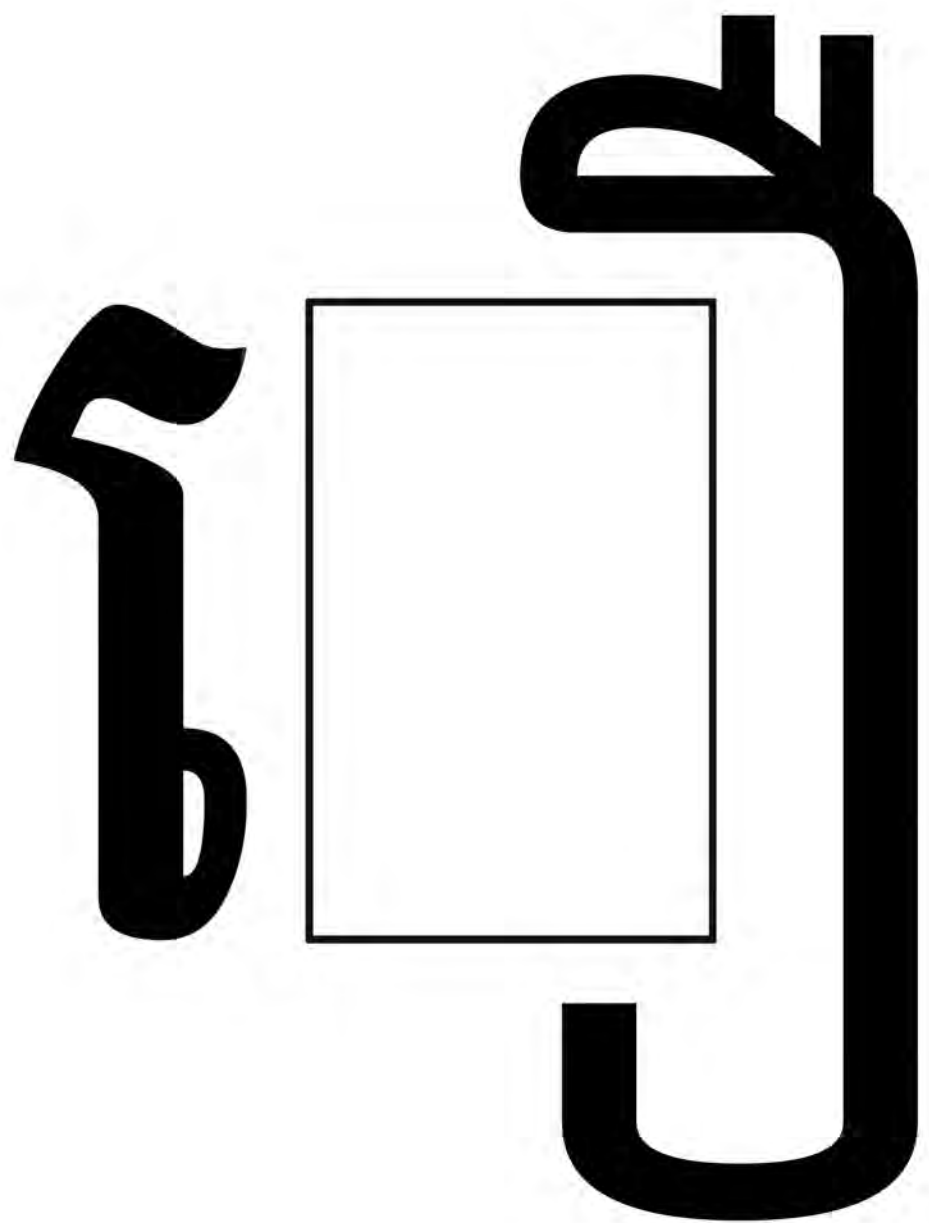

ទៀប

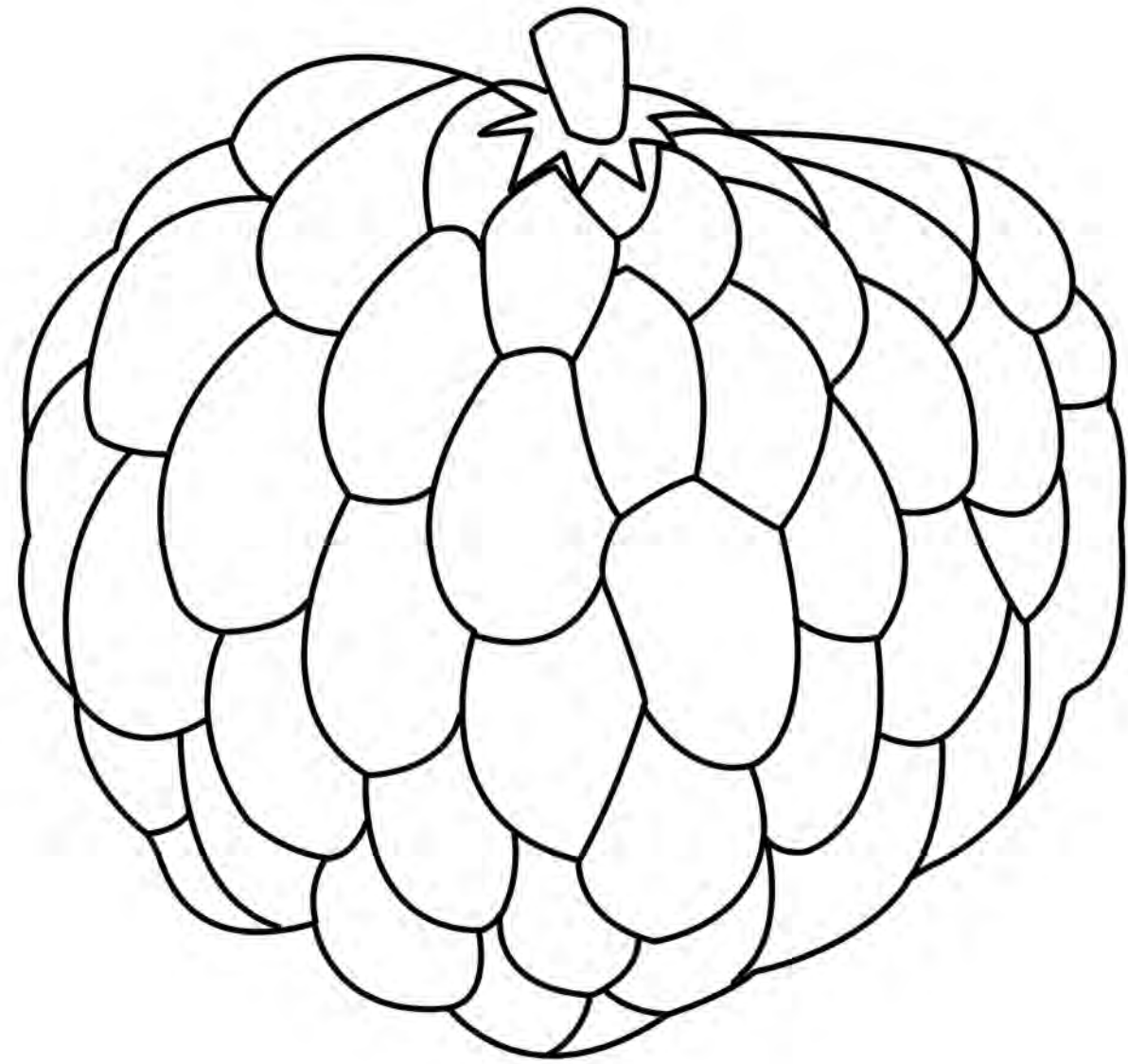
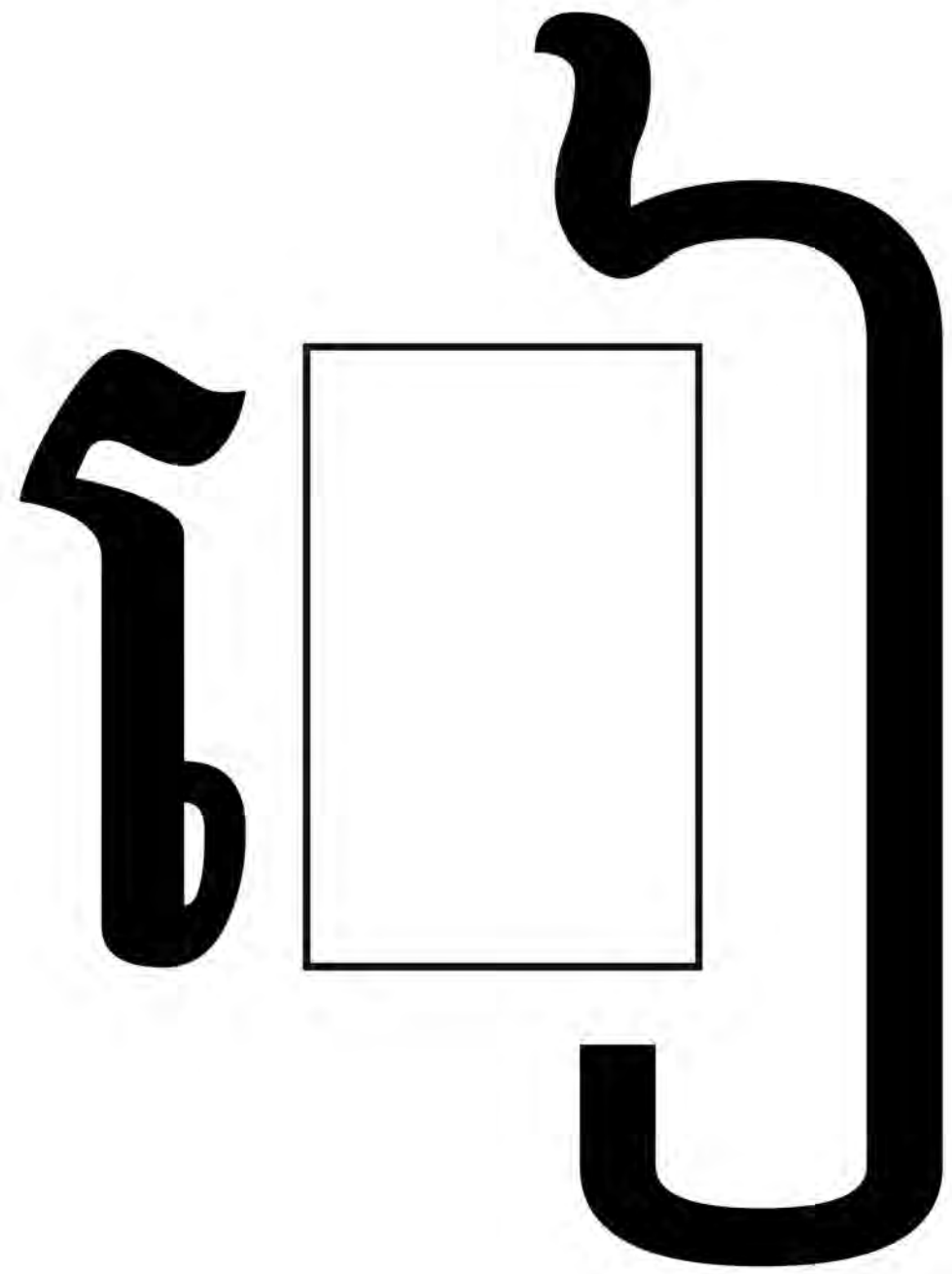

ថែក

ថែក

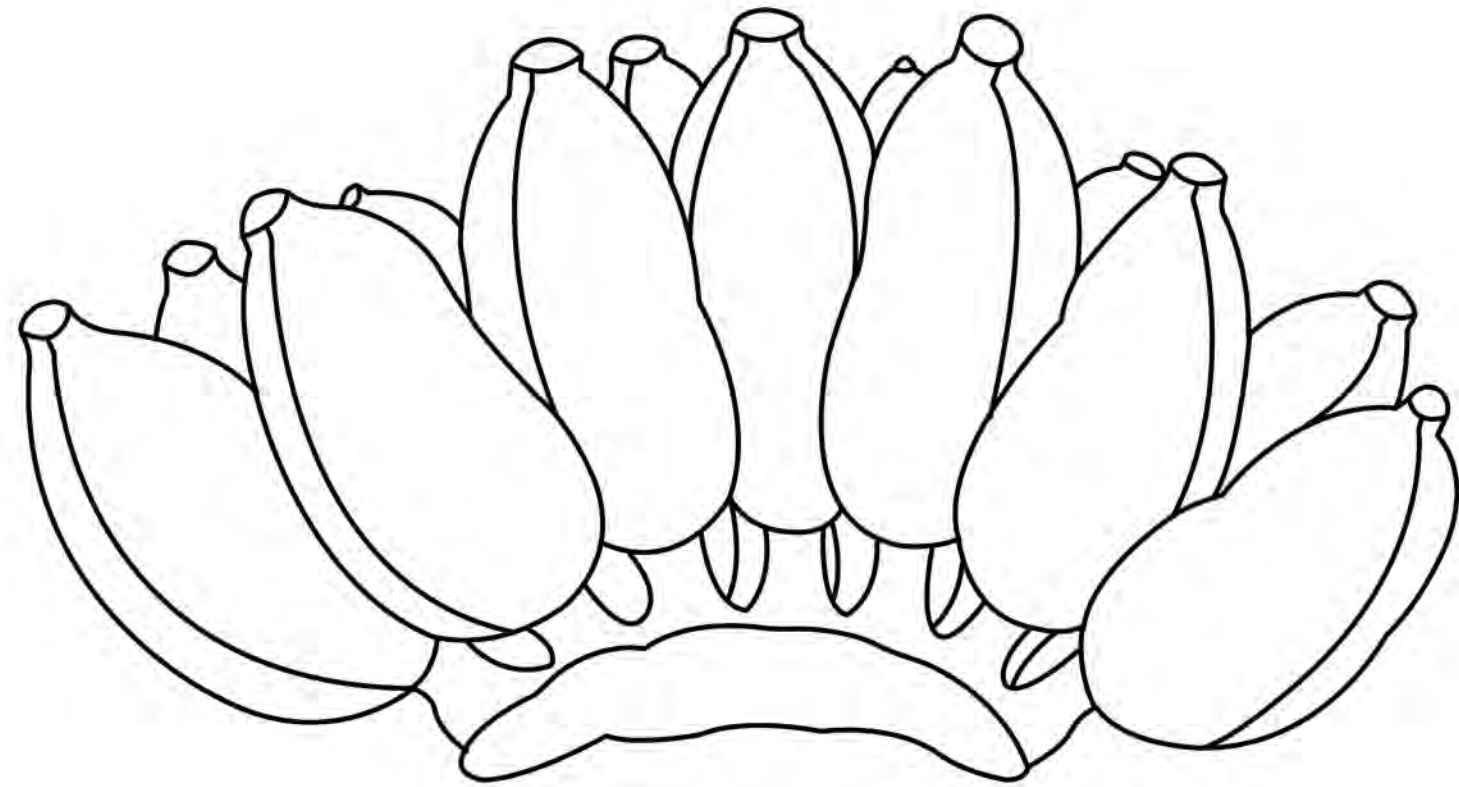
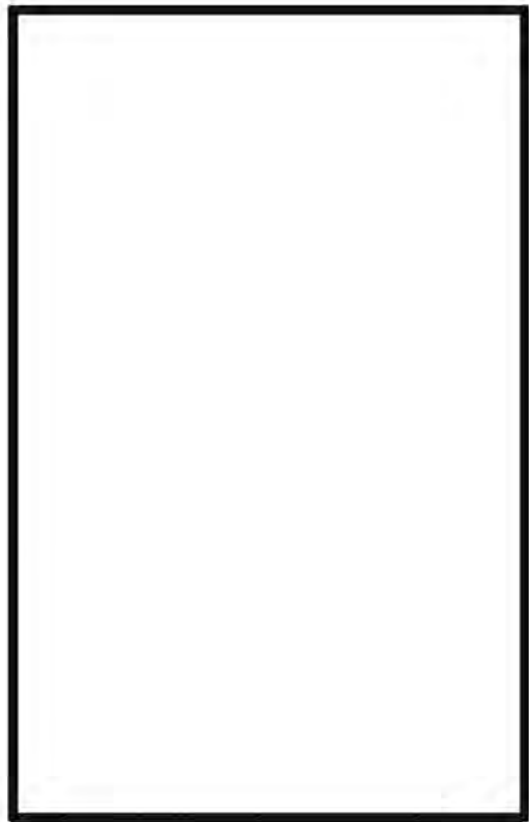

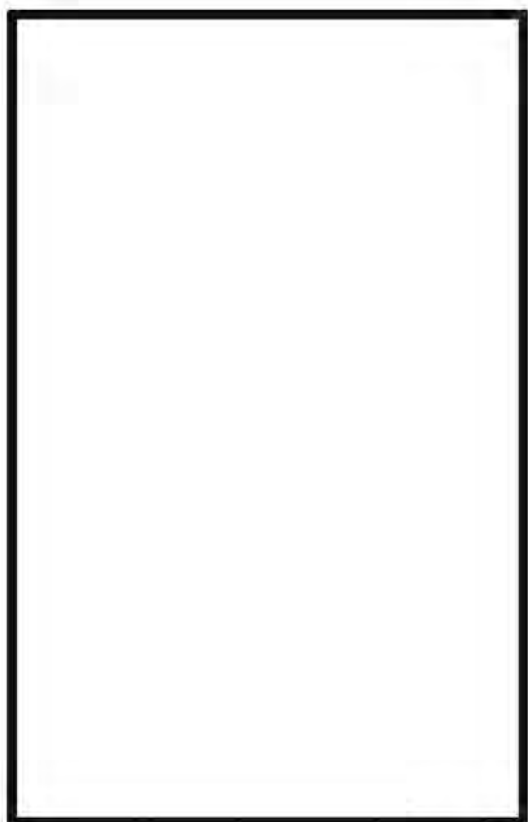
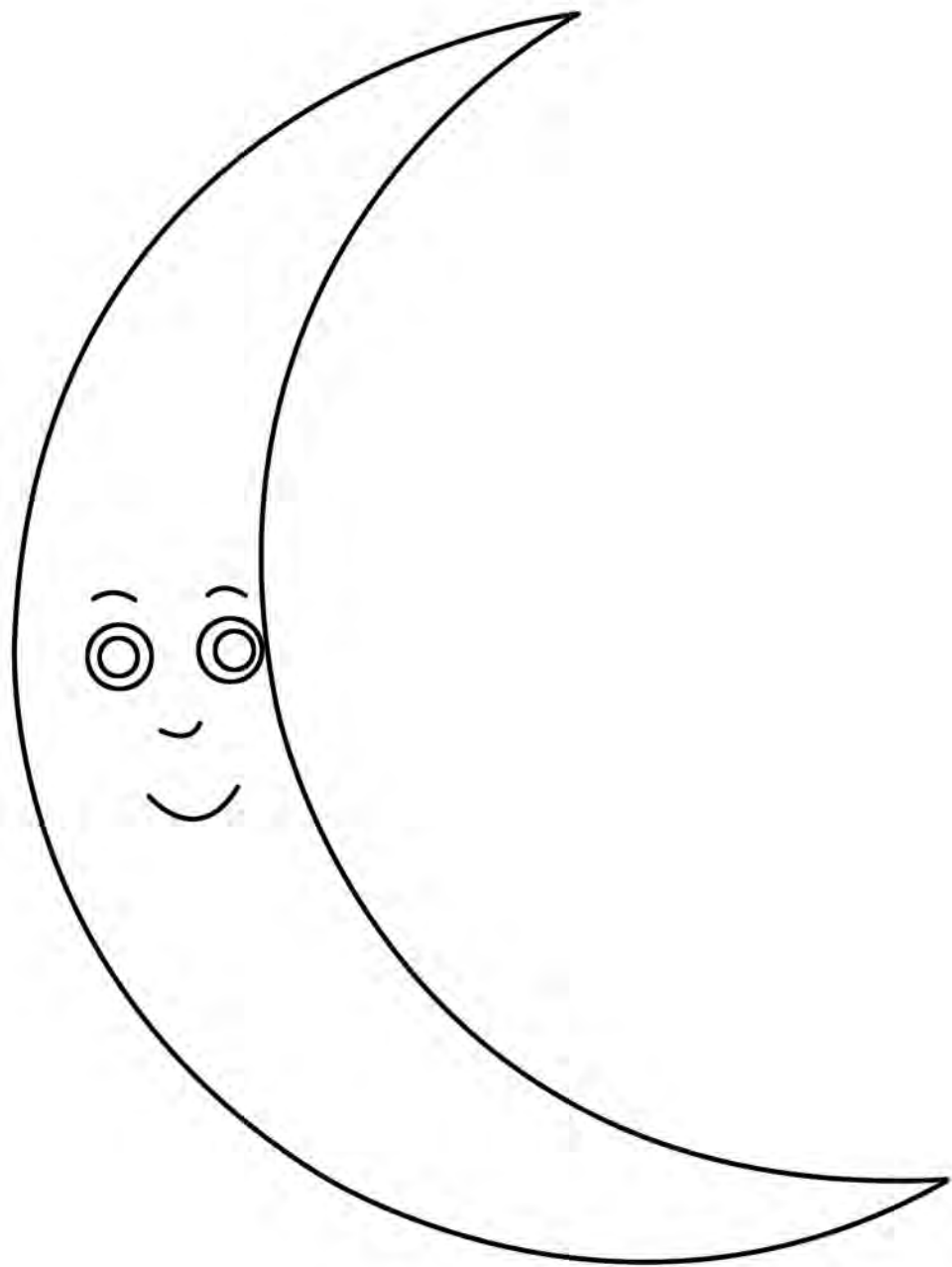

Handwriting practice for the Korean character '하' (ha). The character is shown in a large, bold, black font. To its right is a large, empty rectangular box for tracing or independent practice.

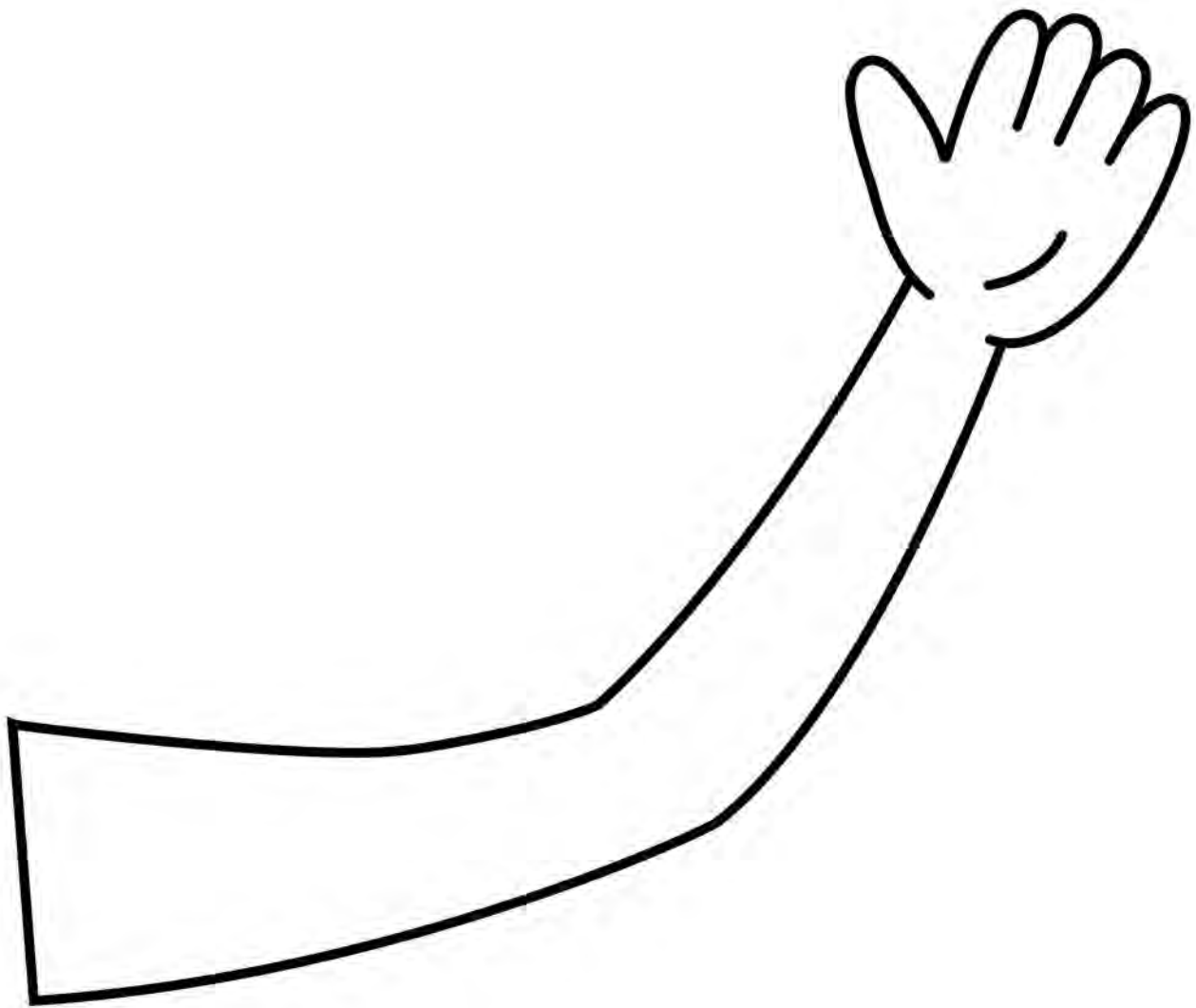

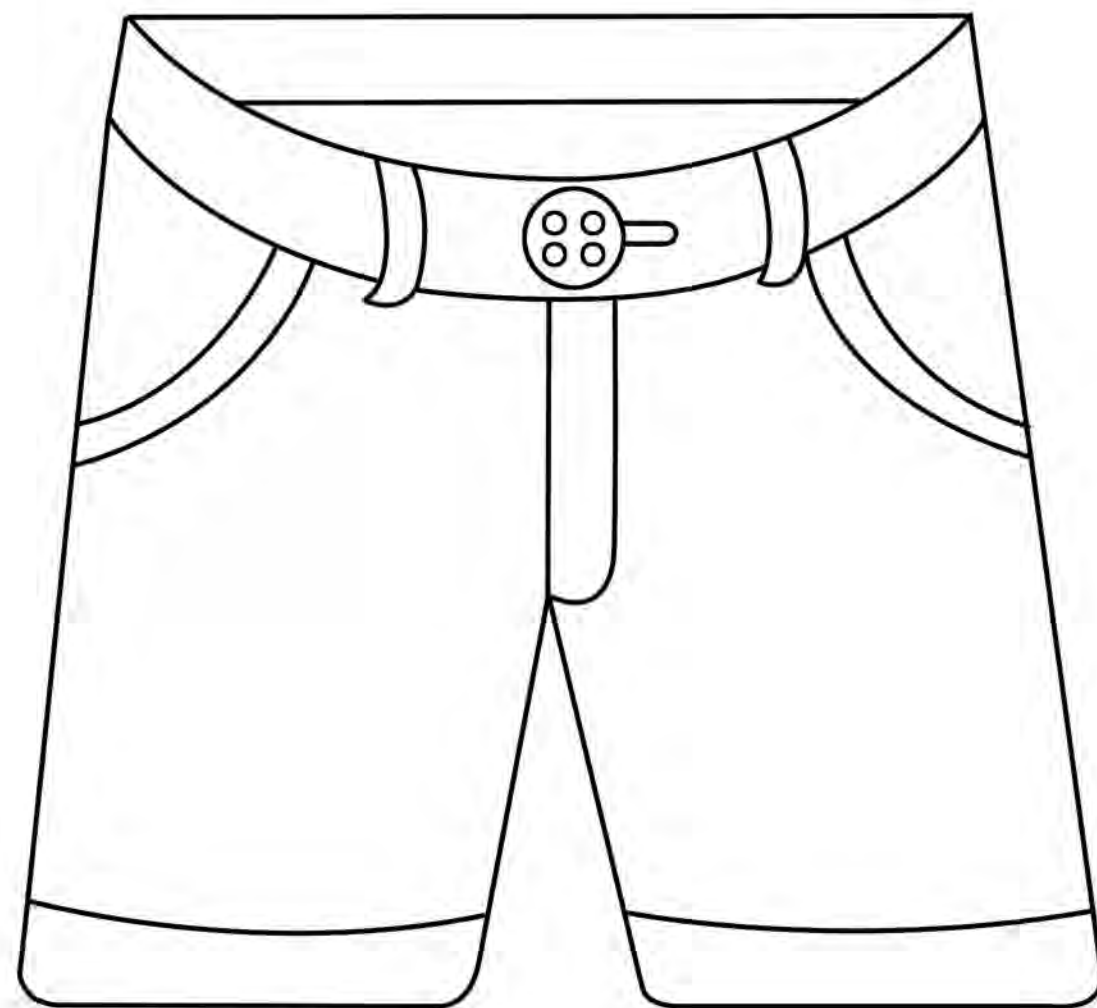
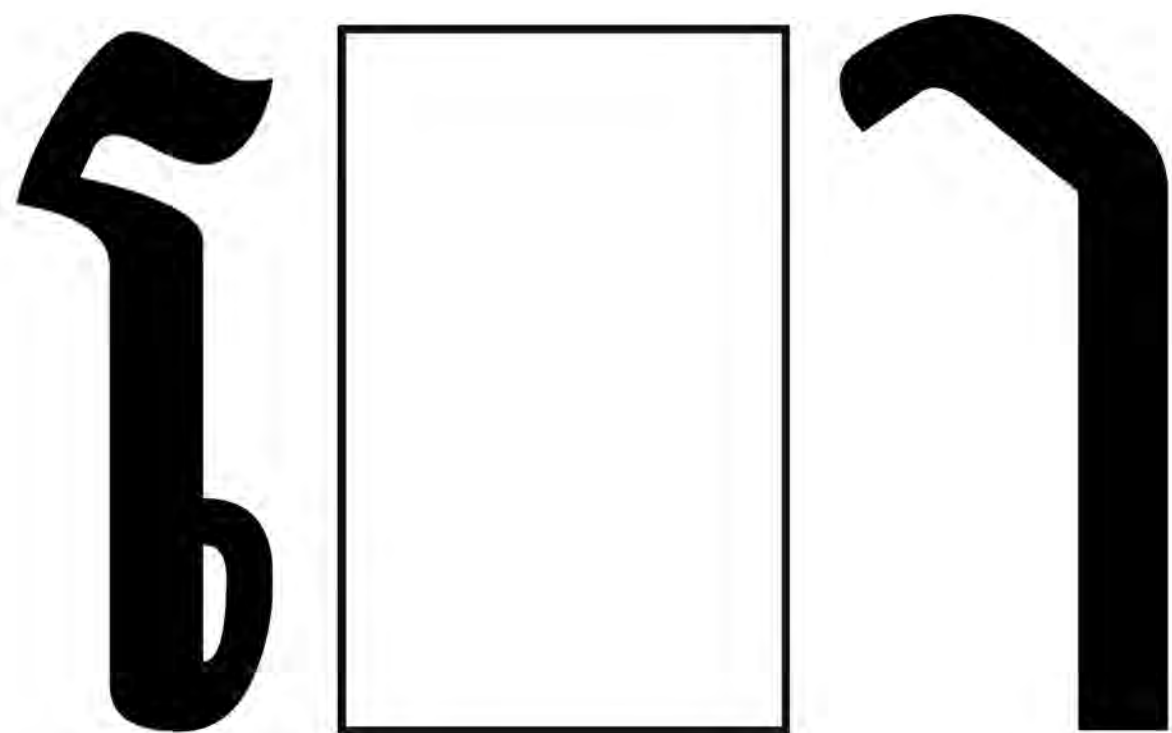

ကျေး

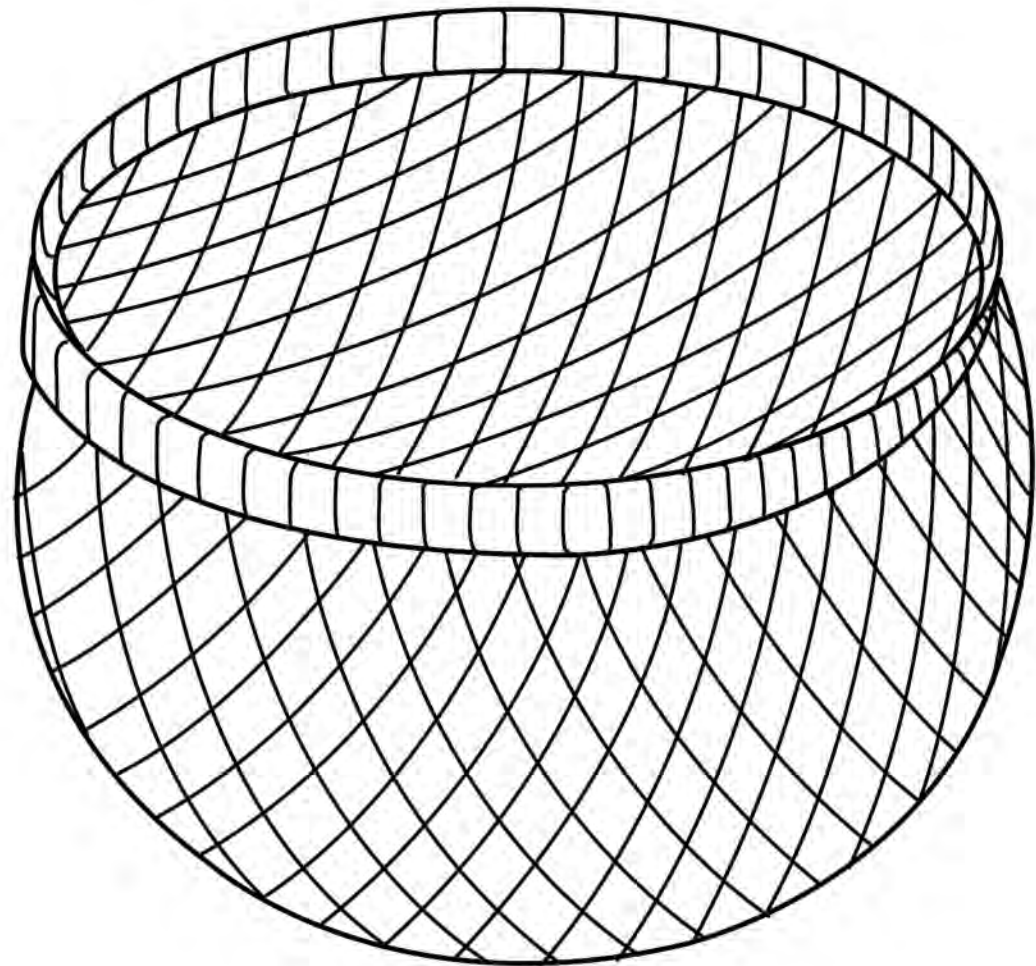
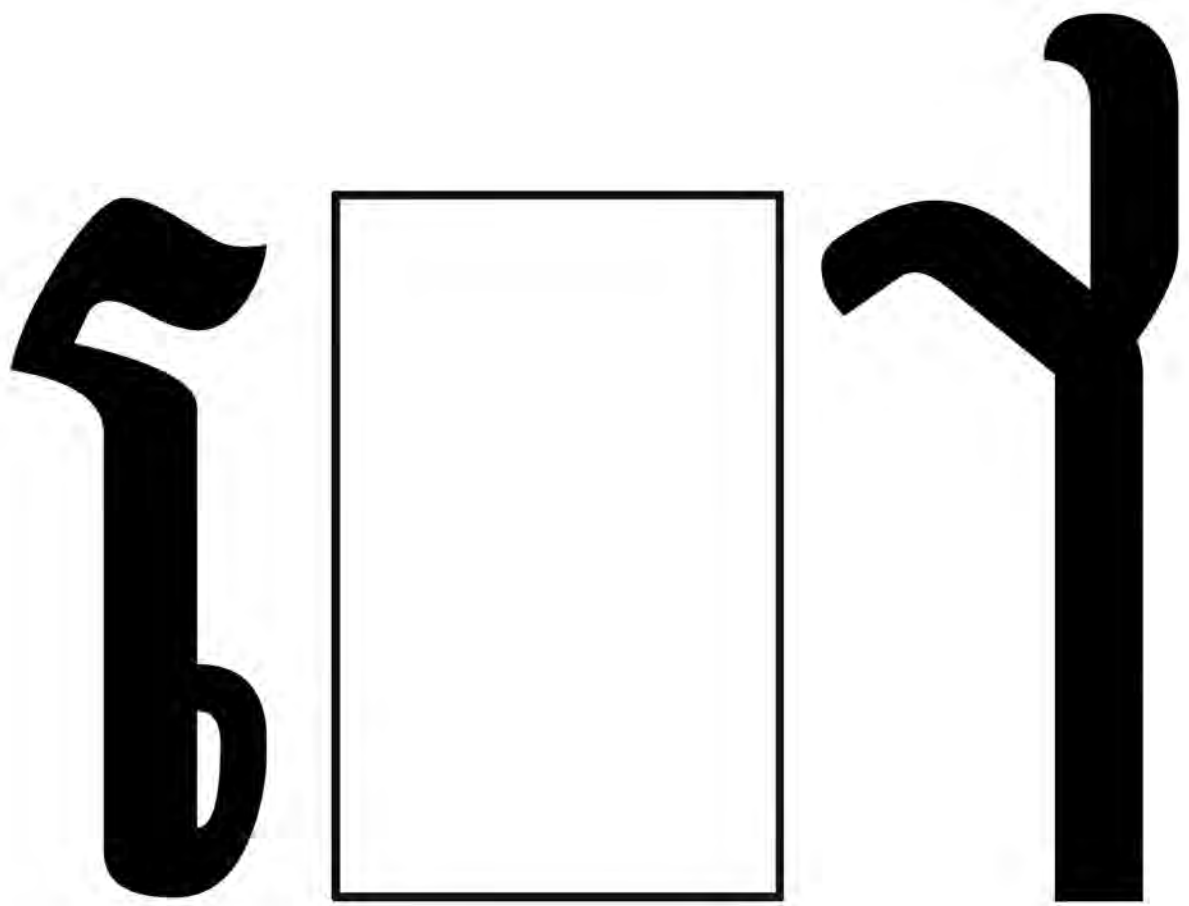

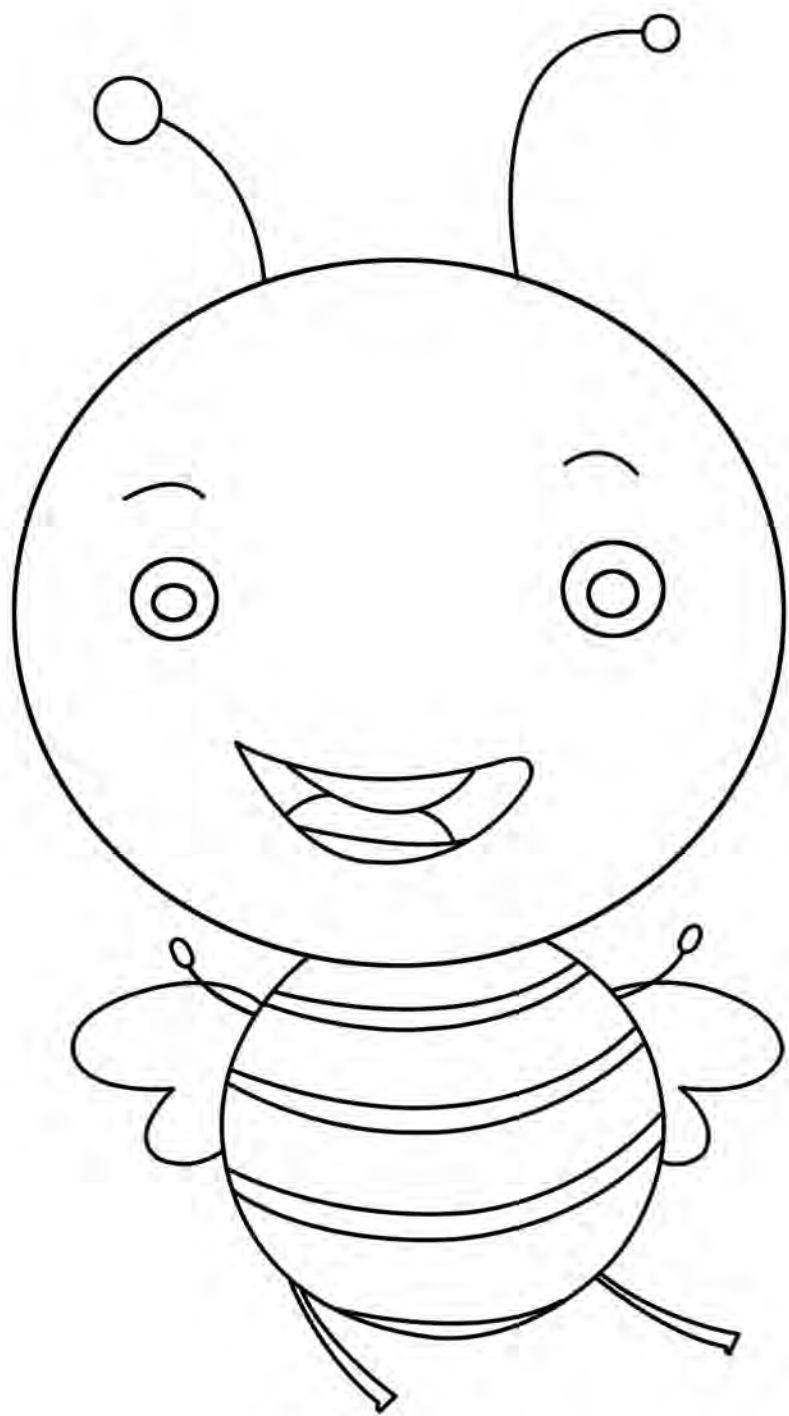

0

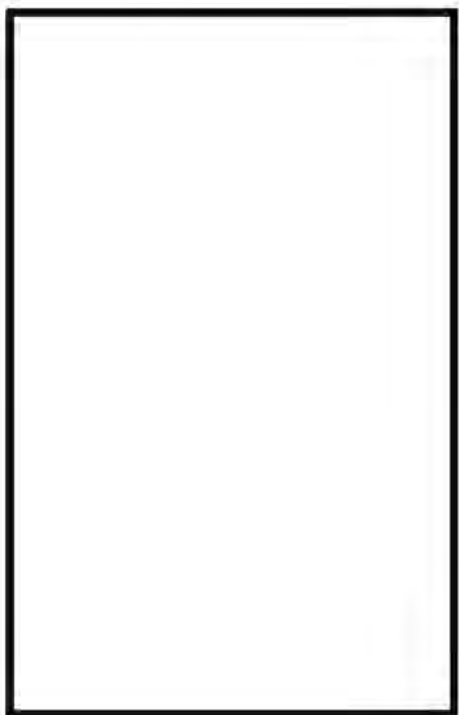

1



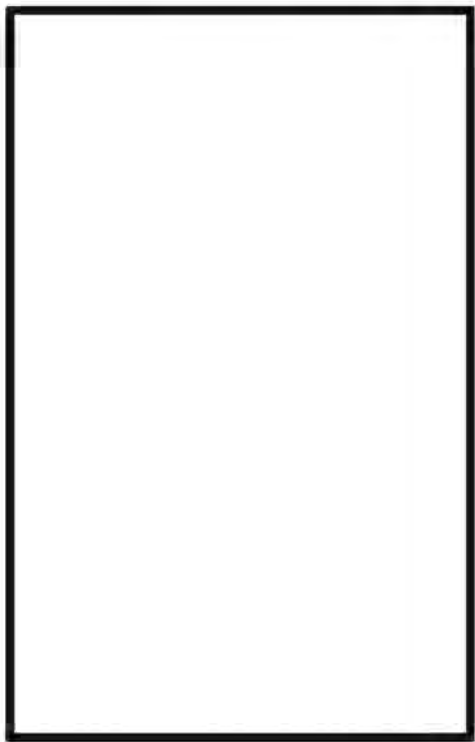

o



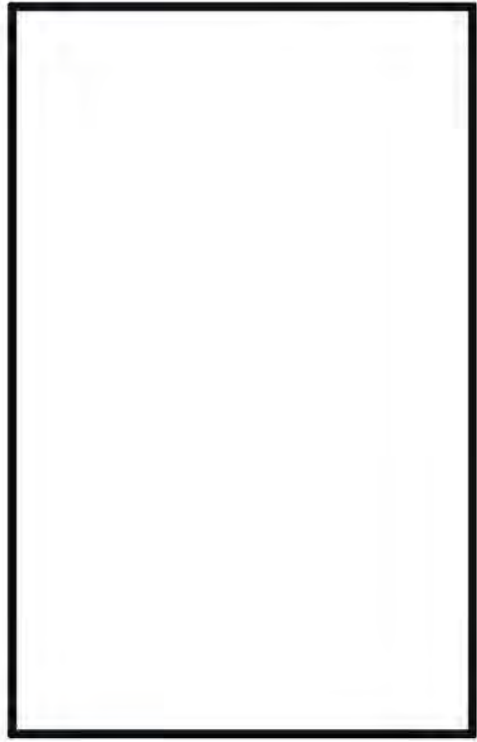

ຂົ້ວ

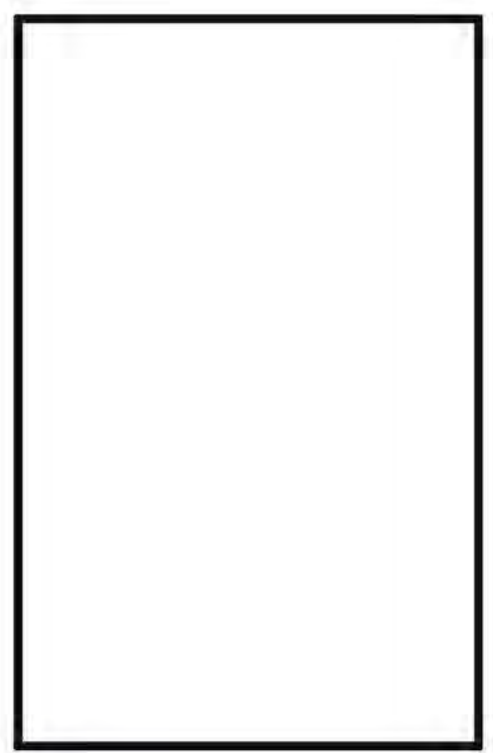

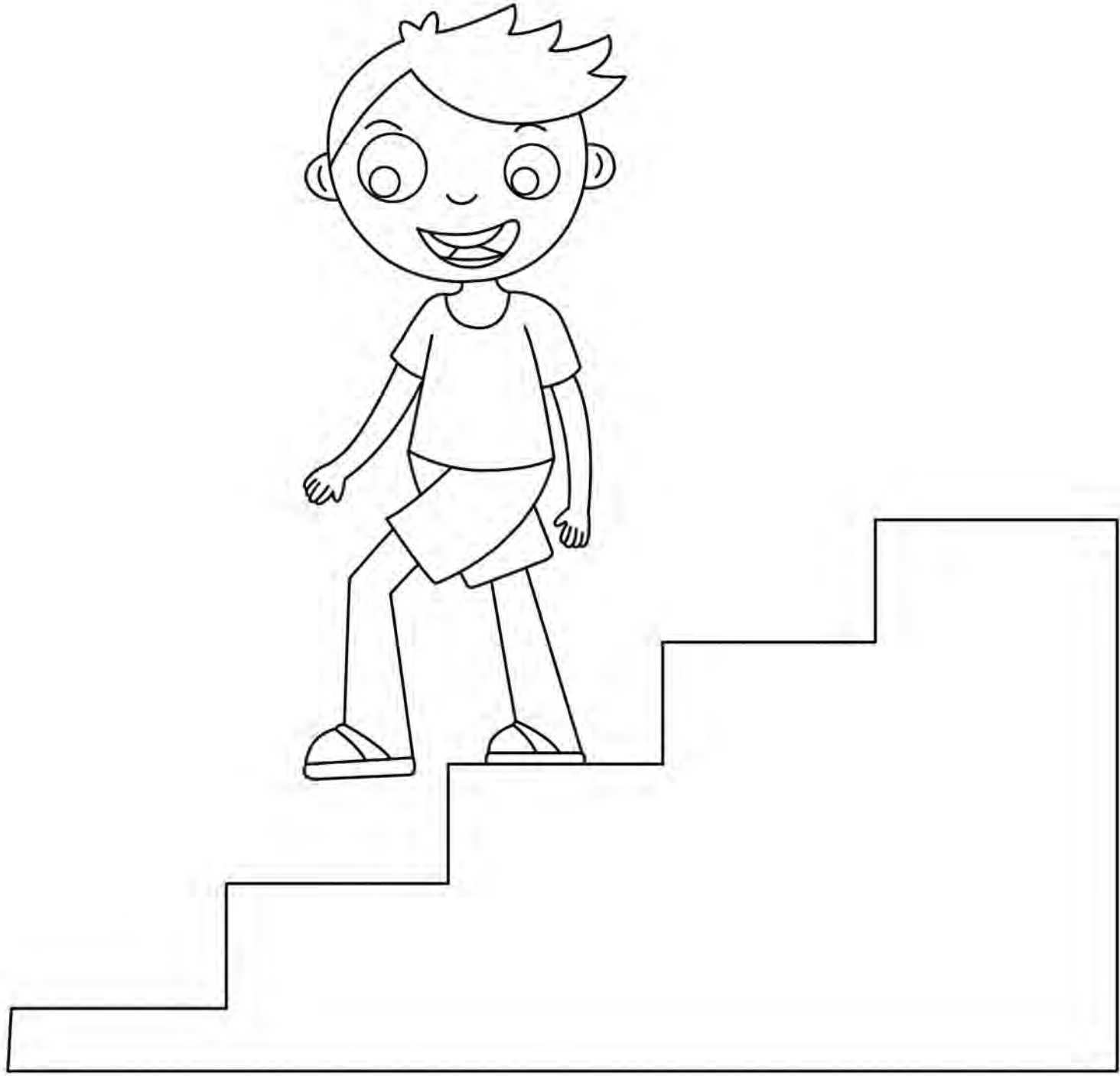
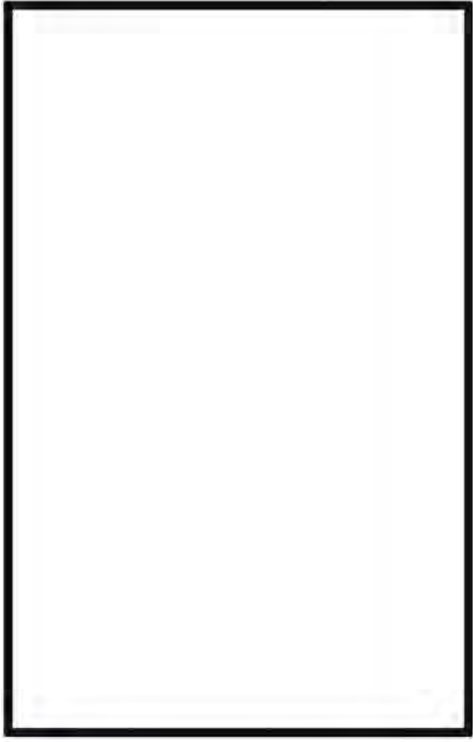

ស៊ែ៖

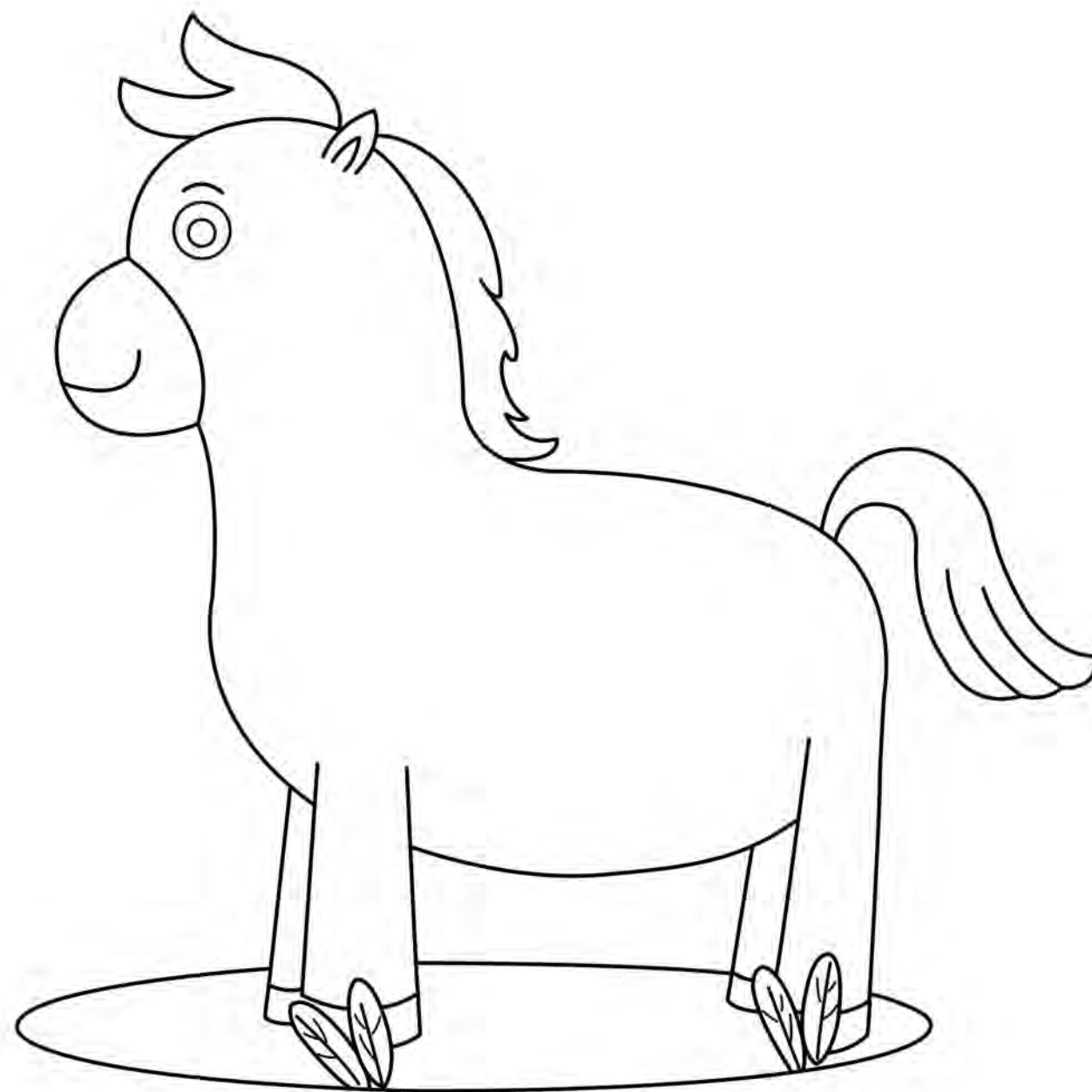
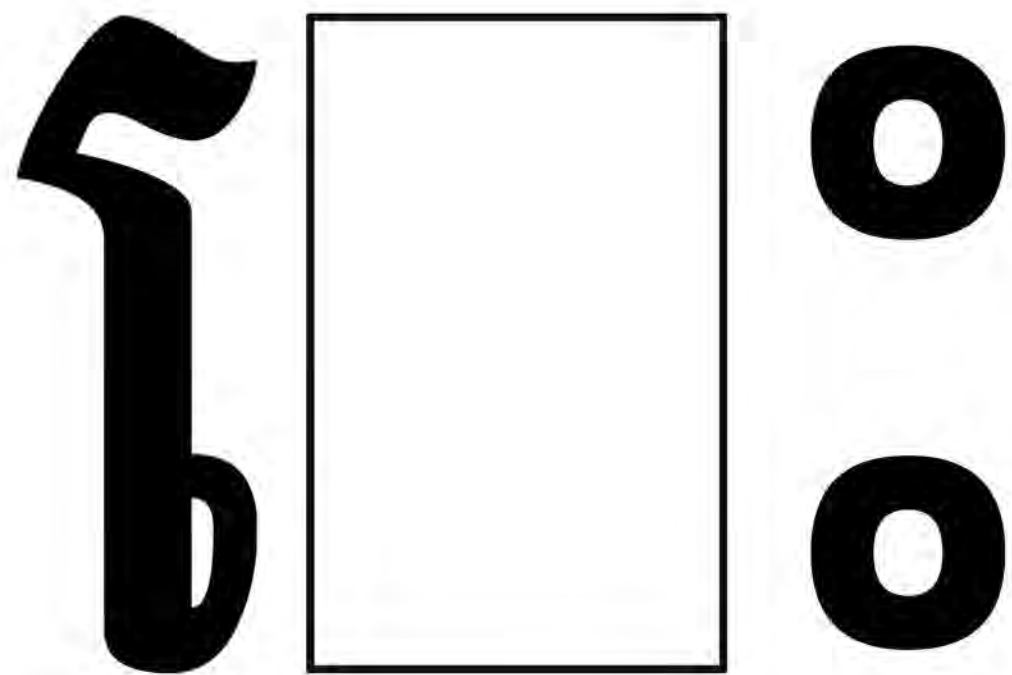

ស្រាវៈ

